

THE PROPERTY OF THE DRAWING IS ESTABLISHED BY LAW. IT IS FORBIDDEN TO PRODUCE OR SHOW IT TO THIRD PART. WITHOUT A WRITTEN AGREEMENT.

Item	Name	Q.ty
1	CA.08.03.008	1
2	CA.08.09.010	1

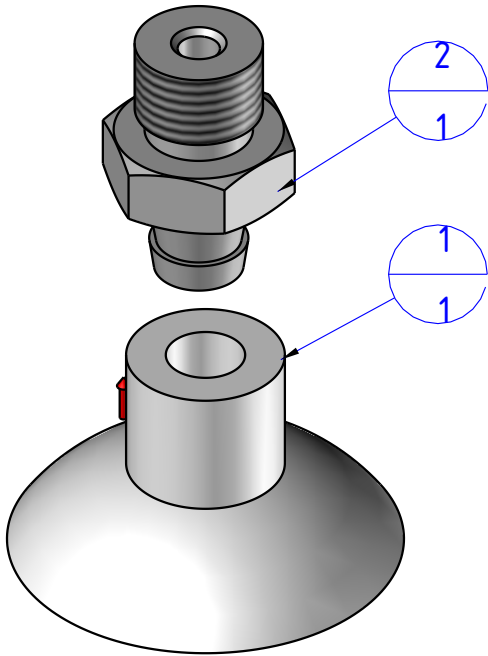
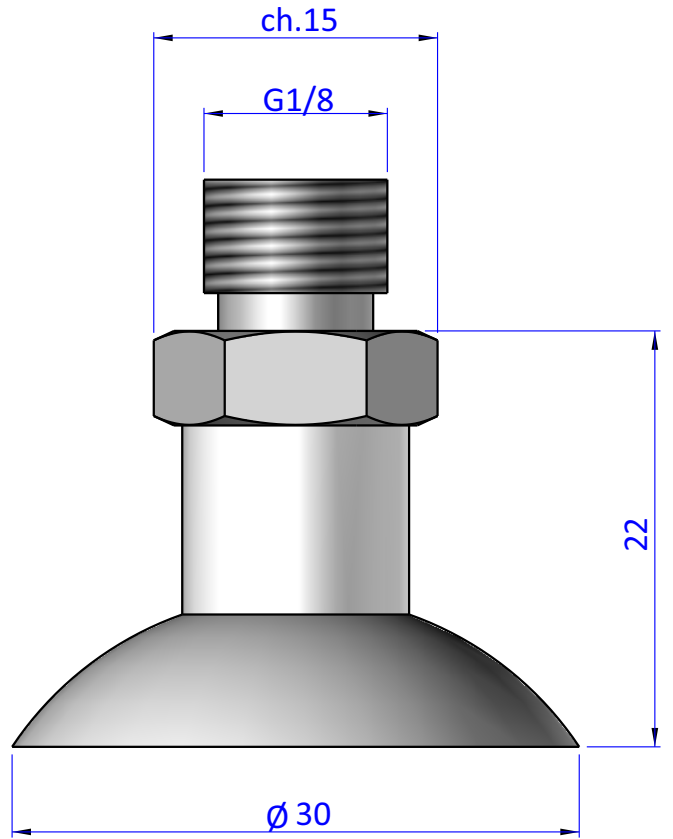

DESIGNED FROM	REVIEW
FPS Automation	A

DATE	WEIGHT
04/11/2020	0,007kg

CODE
KIT.08.03.D30.10

Format A4
UNI 936-76

GENERAL TOLERANCE
UNI - ISO 2768
CLASSE f

DESCRIPTION
KIT.08.03.D30.10